



Инструкция по установке

Toyota RAV4

(2019-)

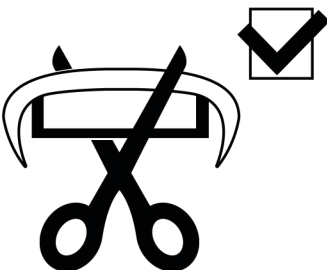

Арт.: F.5717.003

 <p>2000 kg</p>	 <p>100 kg</p>	<p>D = 10,4 kN</p>	
--	---	--------------------	---

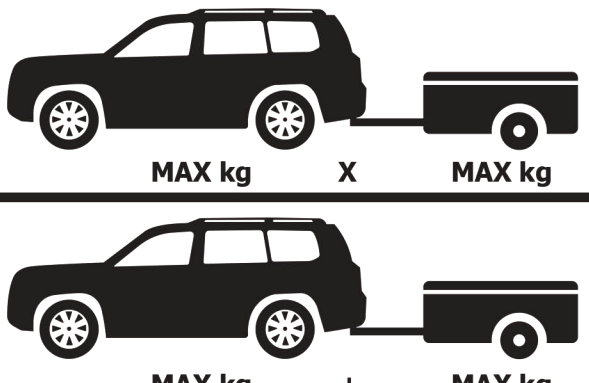
$$D \text{ (kN)} = \frac{\text{MAX kg} \times \text{MAX kg}}{\text{MAX kg} + \text{MAX kg}} \times 0,00981$$

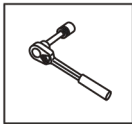

Вкрутить/выкрутить используя инструмент

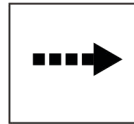

Движение



Поворот





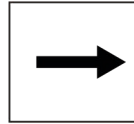





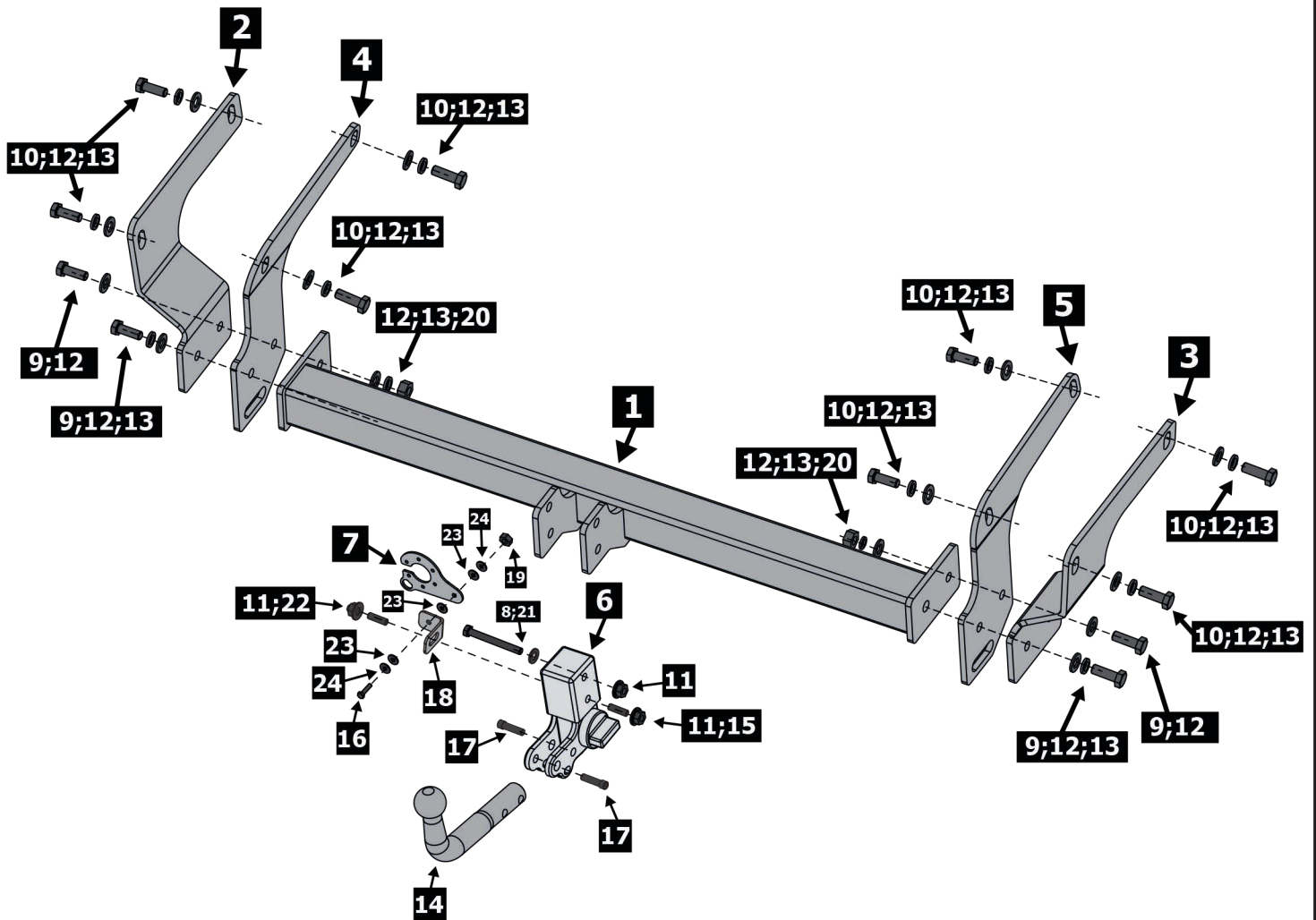
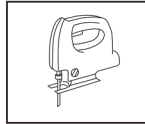
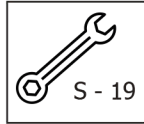
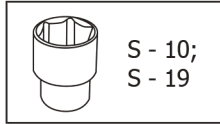
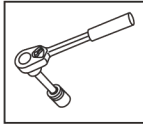

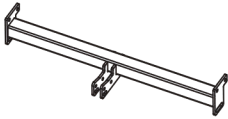
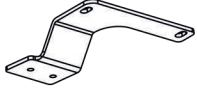



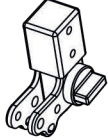

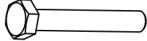





Вкрутить/выкрутить не затягивая

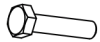
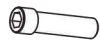

Расположение

Используемый инструмент:



1	x1	Балка	
2	x1	Кронштейн внешний левый	
3	x1	Кронштейн внешний правый	
4	x1	Кронштейн внутренний левый	
5	x1	Кронштейн внутренний правый	
6	x1	Быстросъемный крюк	
7	x1	Подрозетник	
8	x2	M12x100	
9	x4	M12x1.25x50	
10	x8	M12x1.25x35	
11	x3	M12	
12	x12	∅ 12	
13	x14	∅ 12	
14	x1	Крюк	
15	x1	Шпилька M12x35	
16	x1	M6x25	
17	x2	M12x45	
18	x1	Уголок	
19	x1	M6	
20	x2	M12x1.25	
21	x1	∅ 12	
22	x1	Шпилька M12x25	
23	x3	∅ 6 (полиамид)	
24	x2	∅ 6	

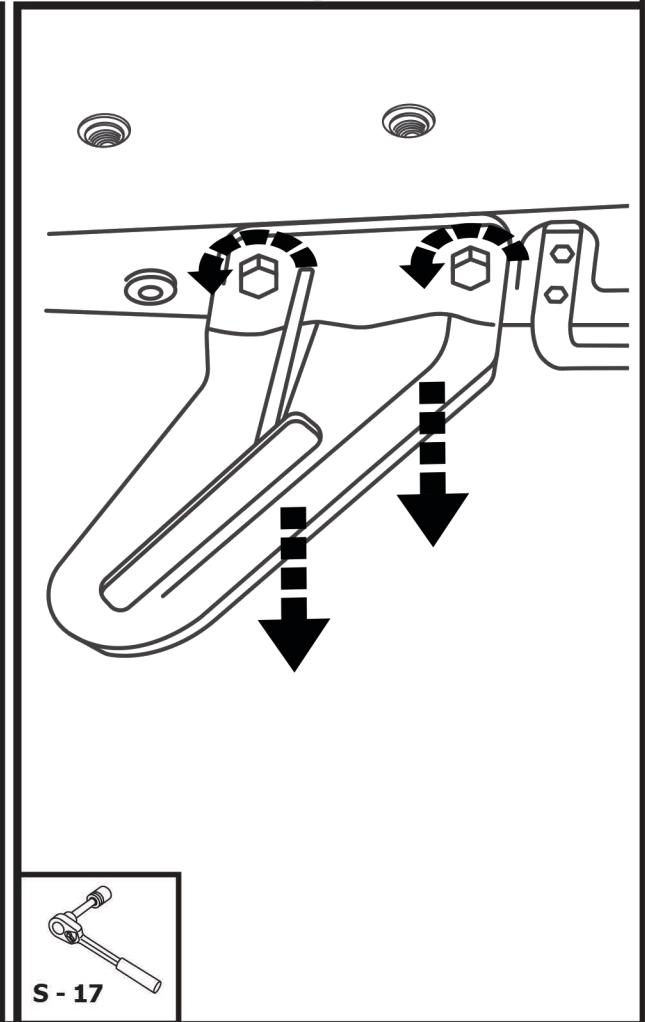
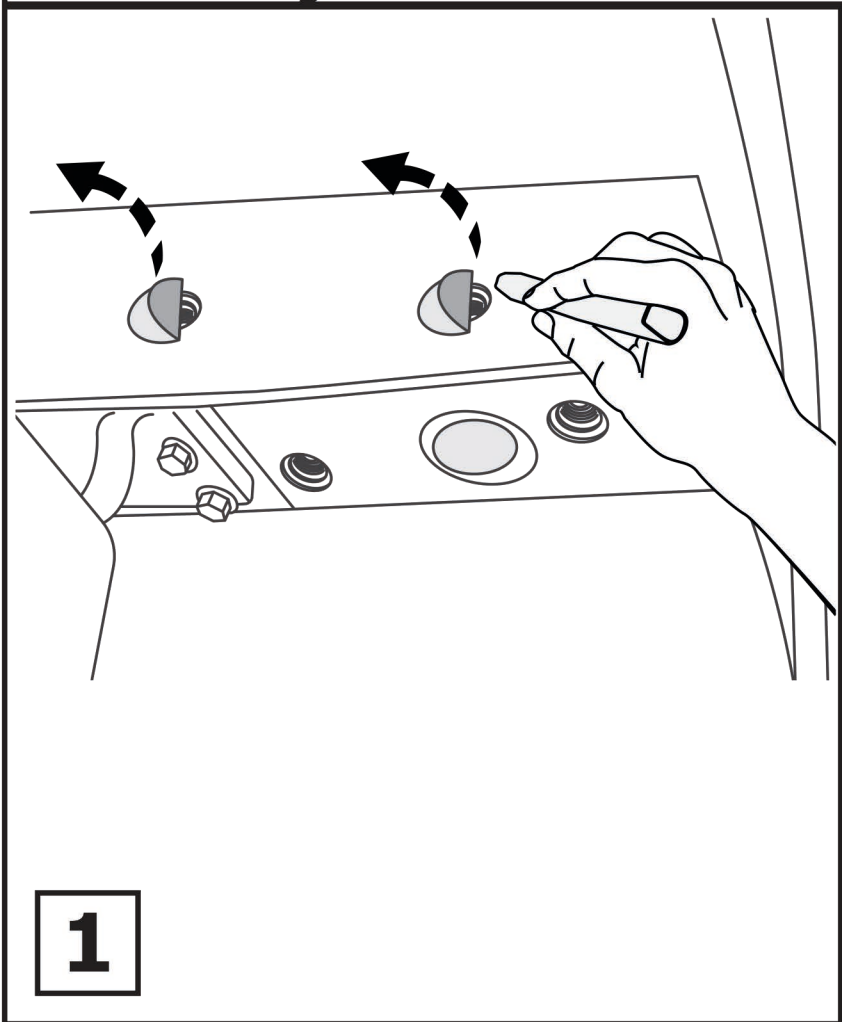
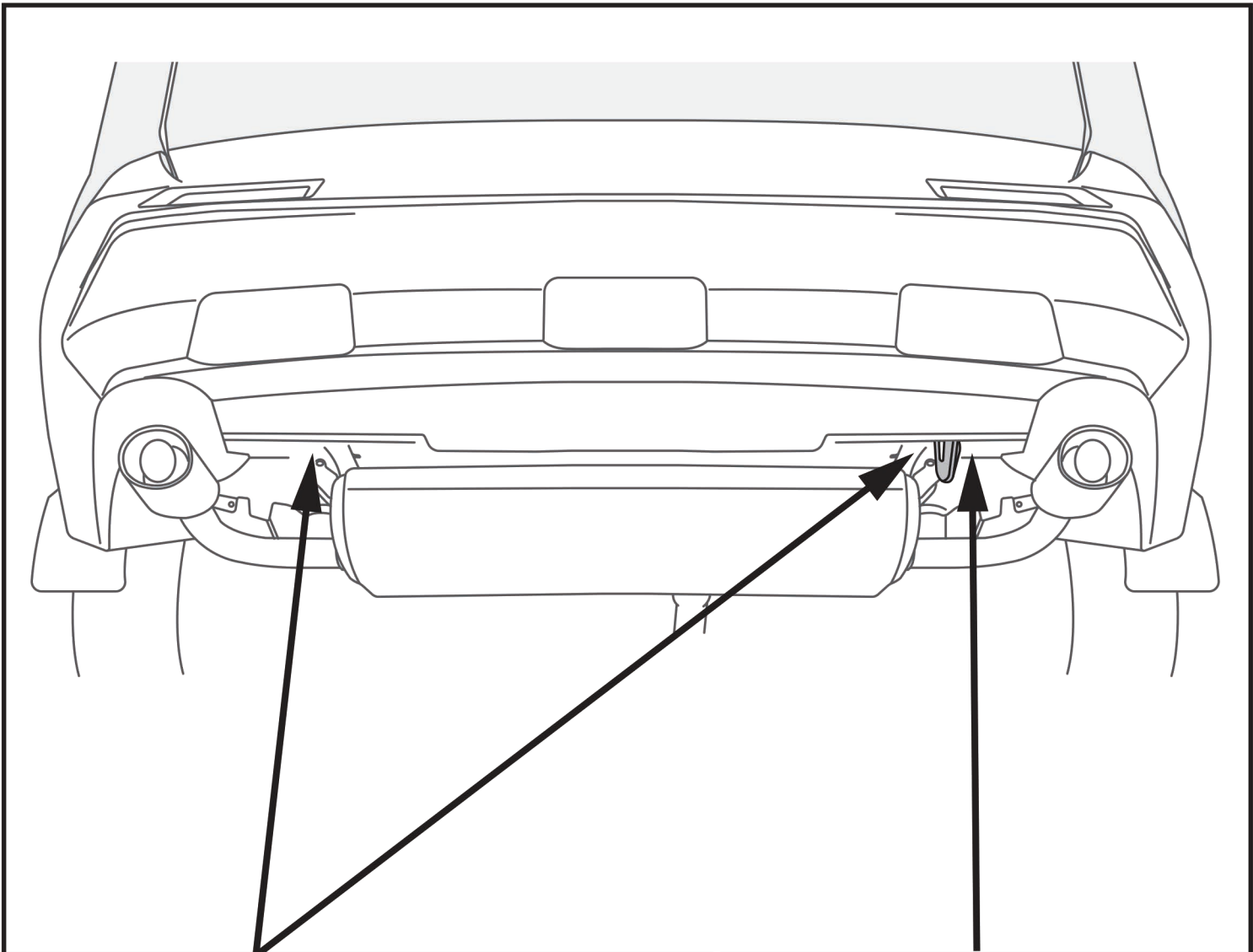

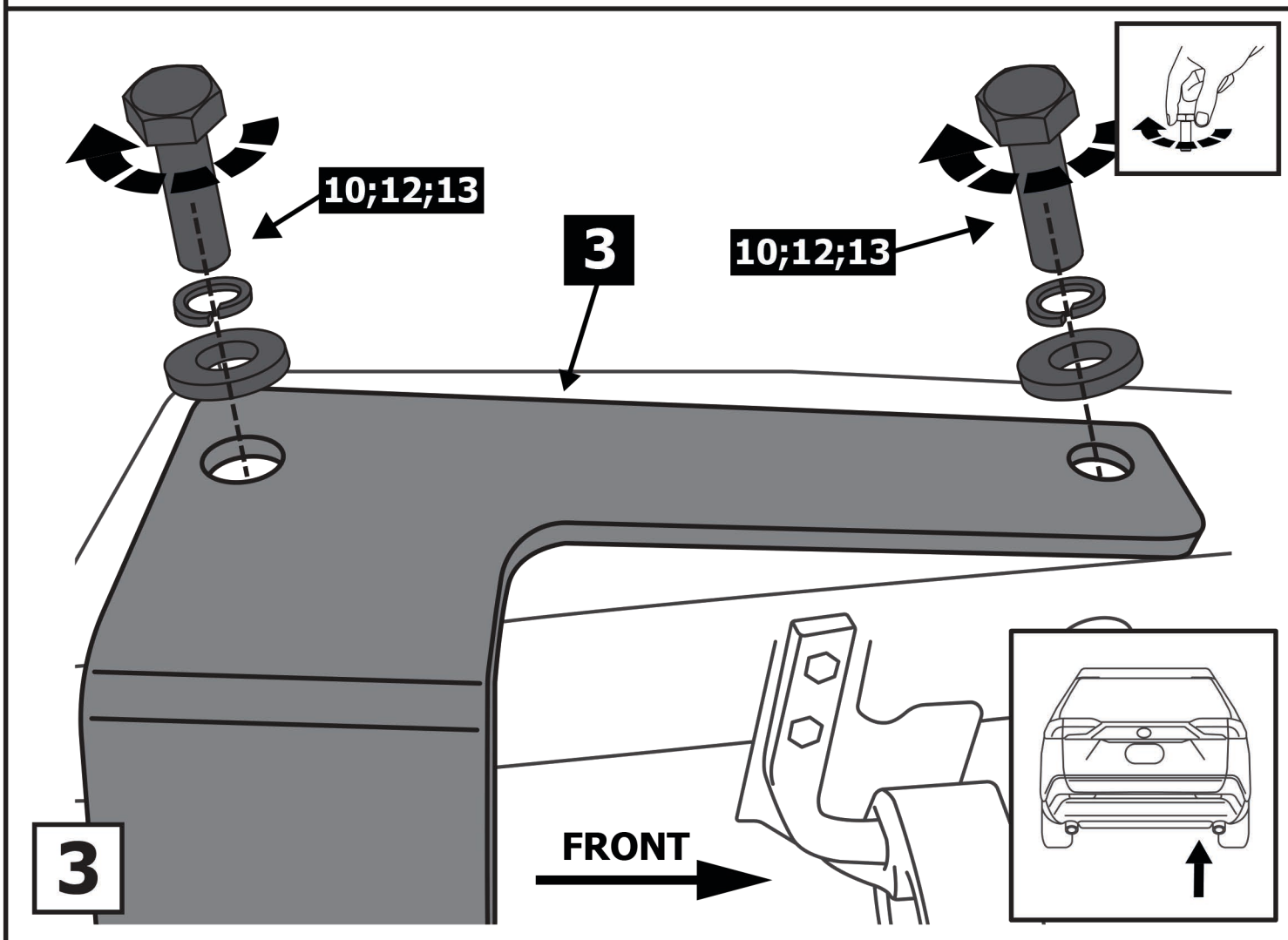
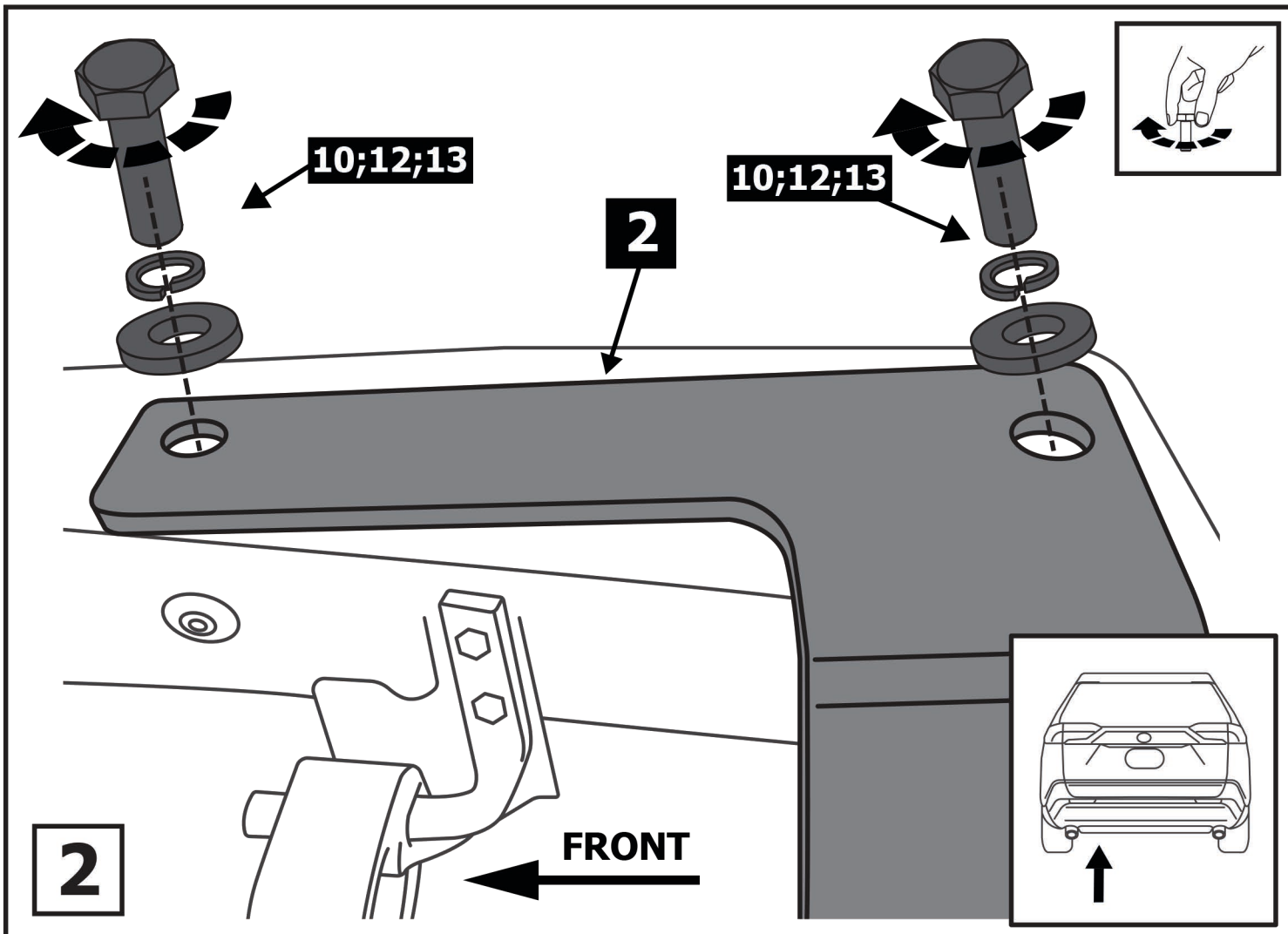

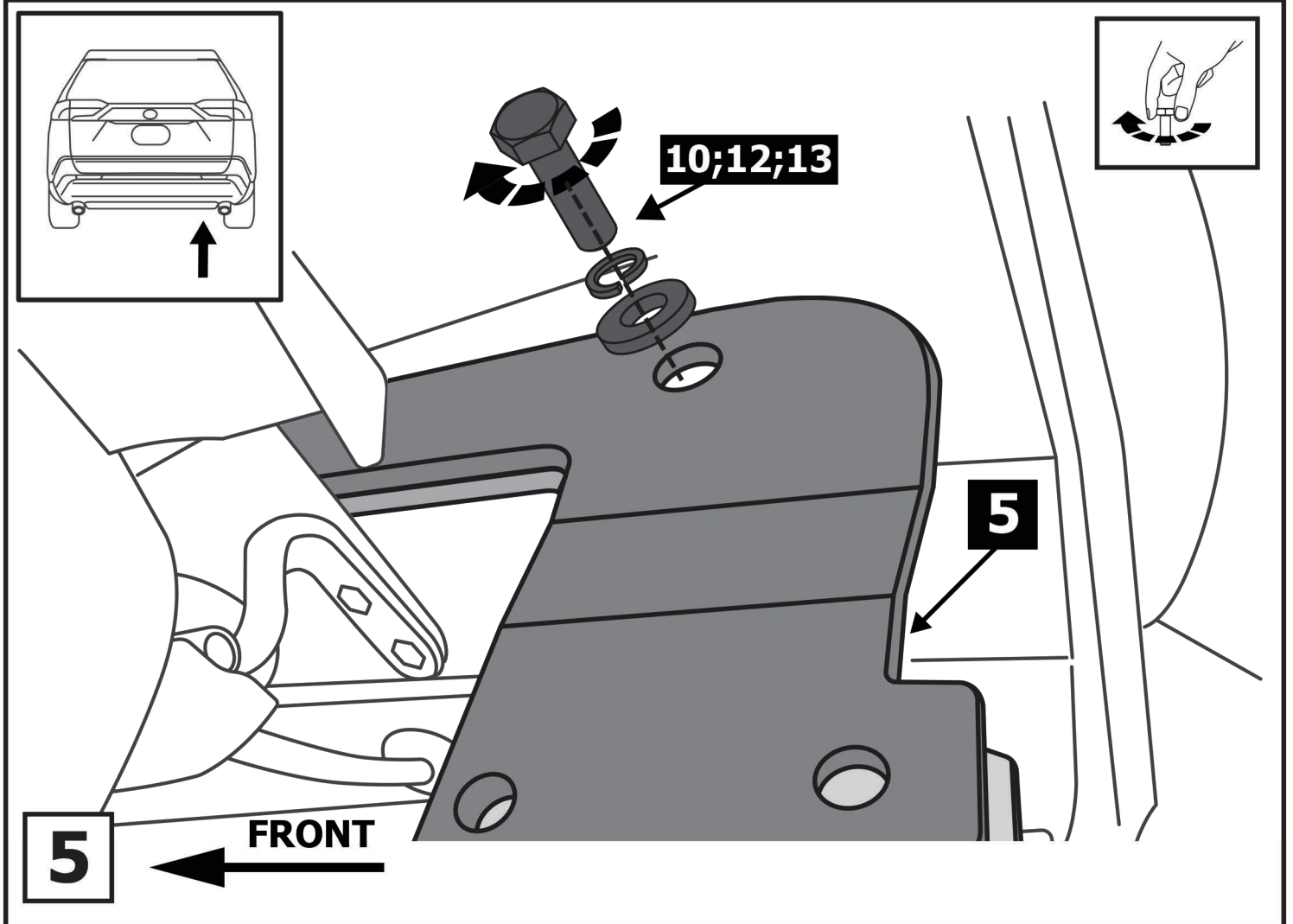
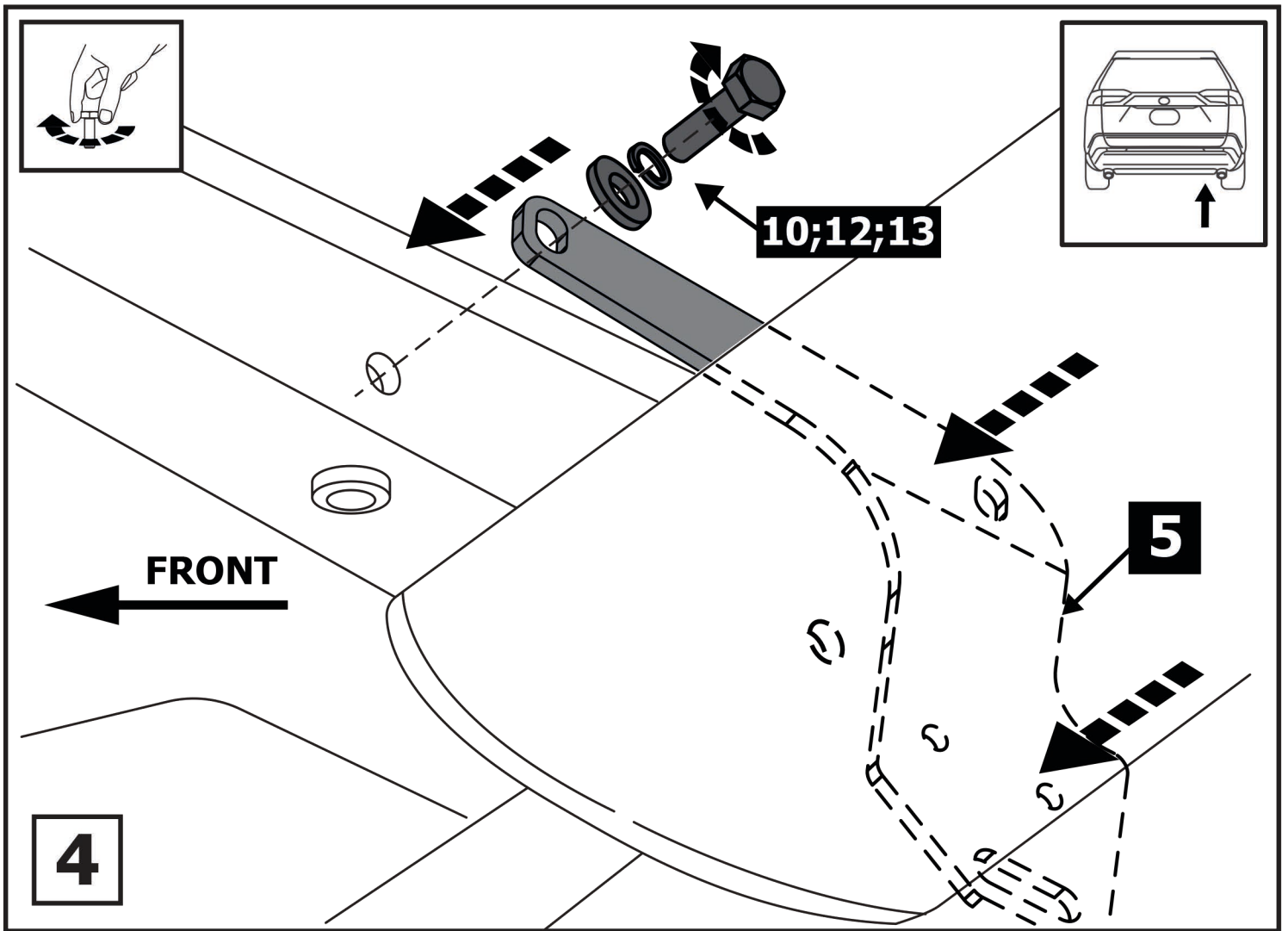

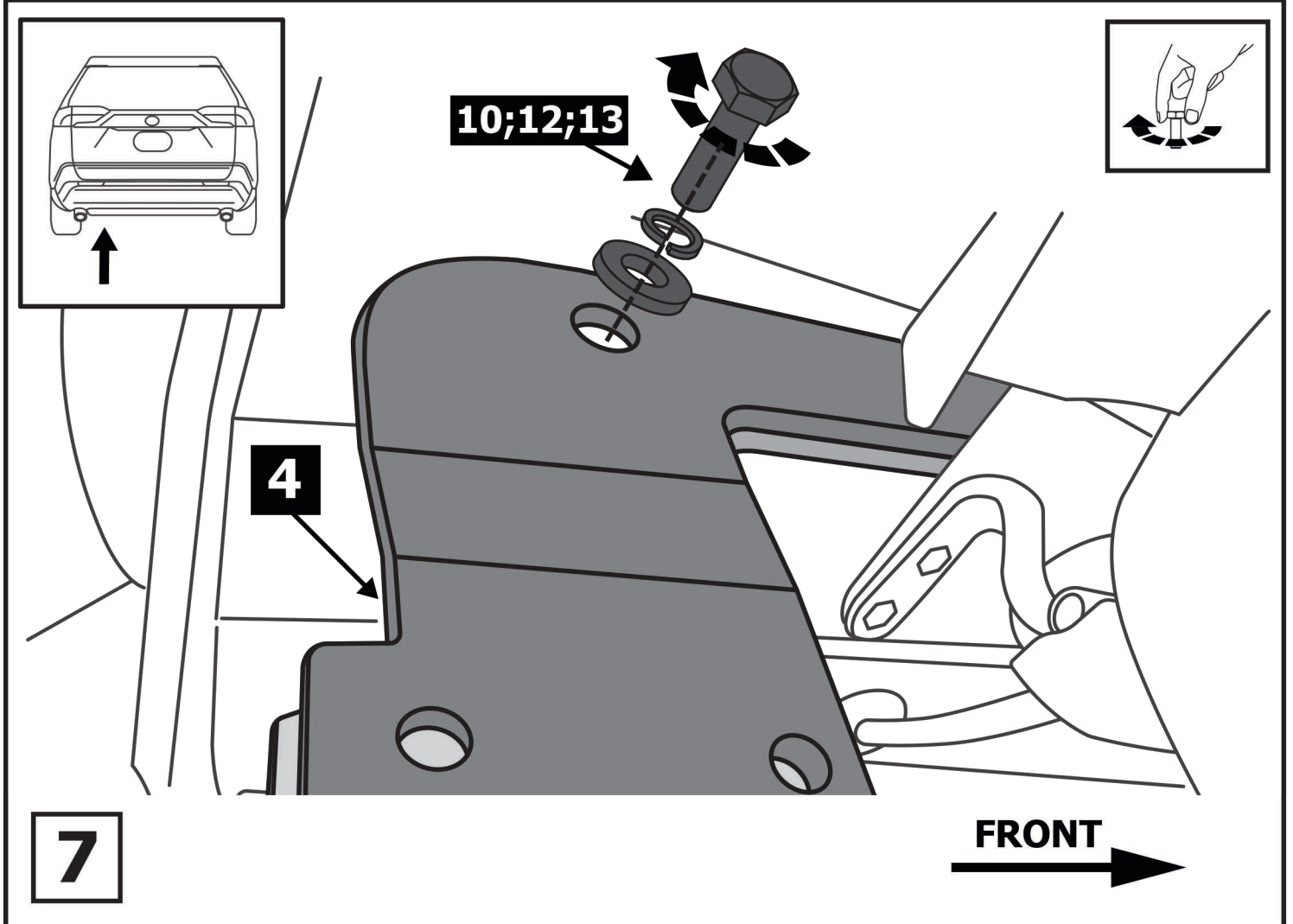
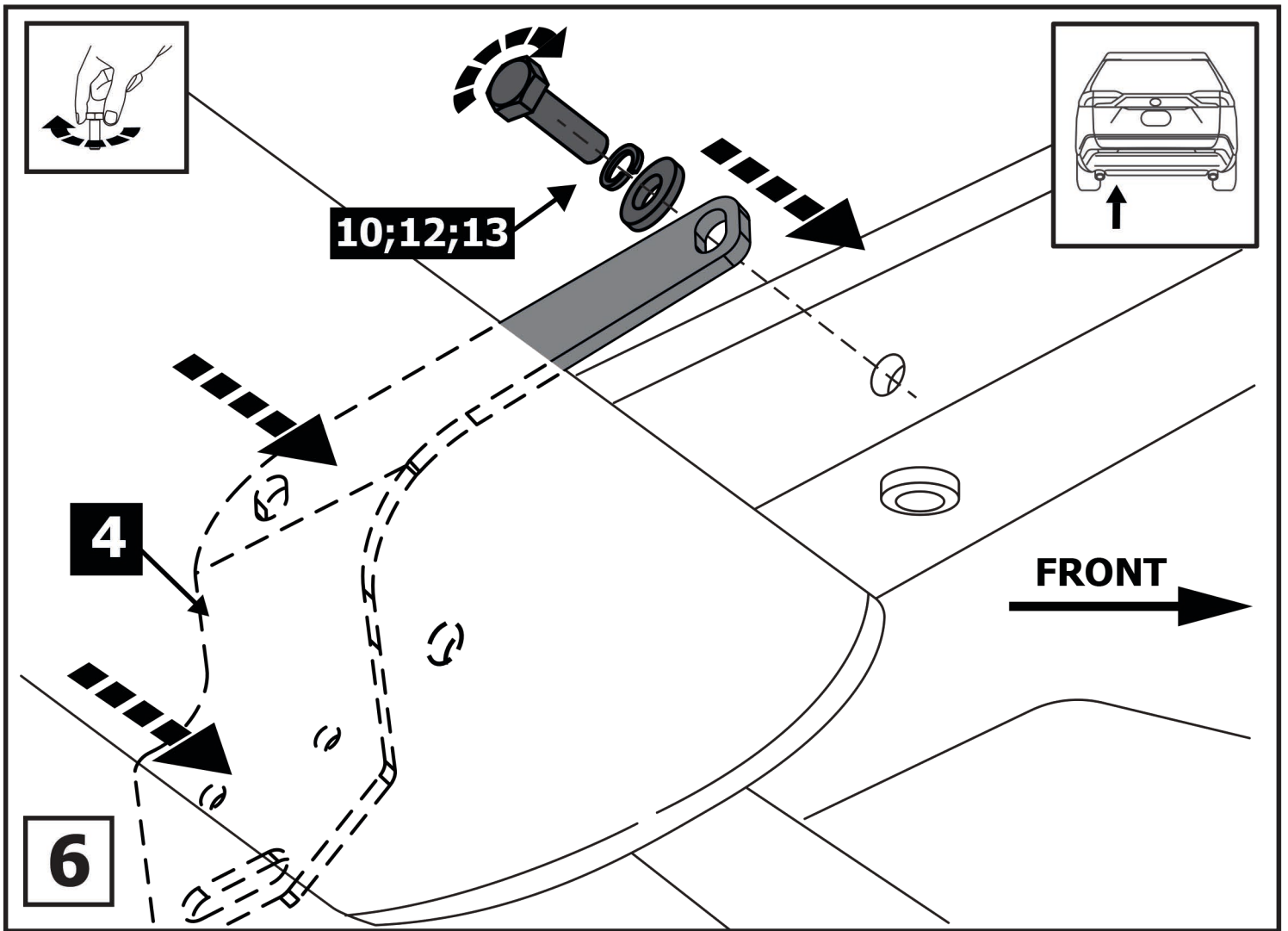

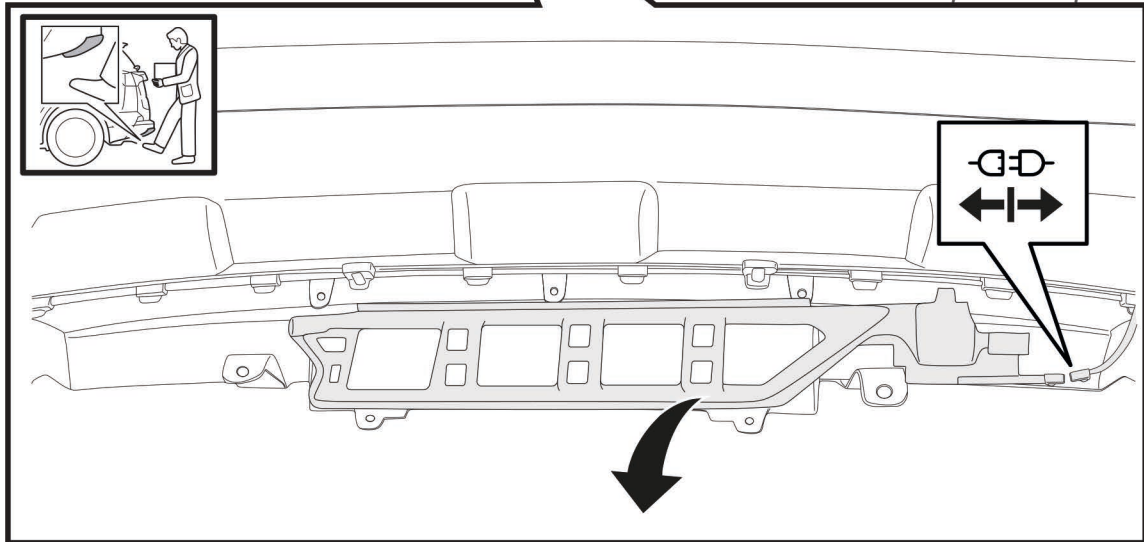
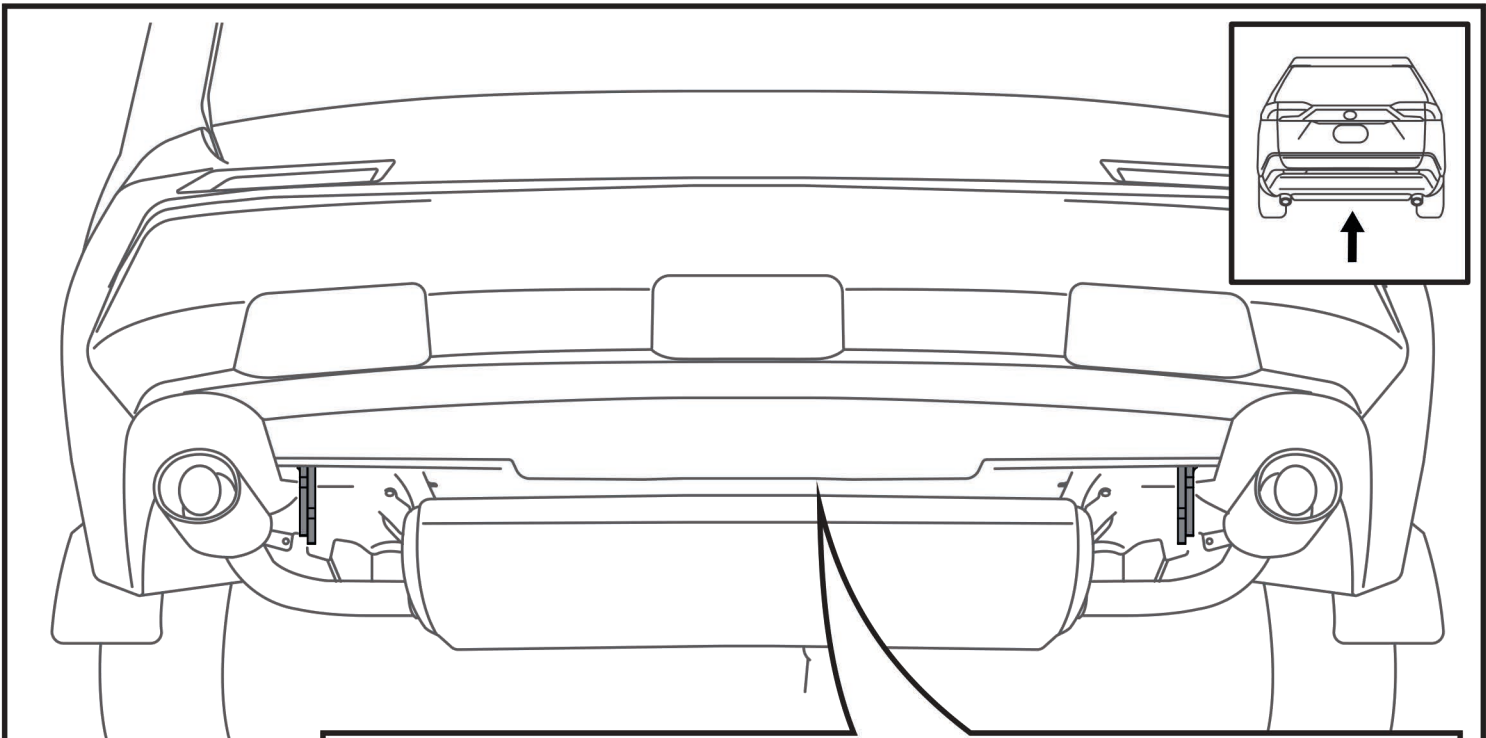

8

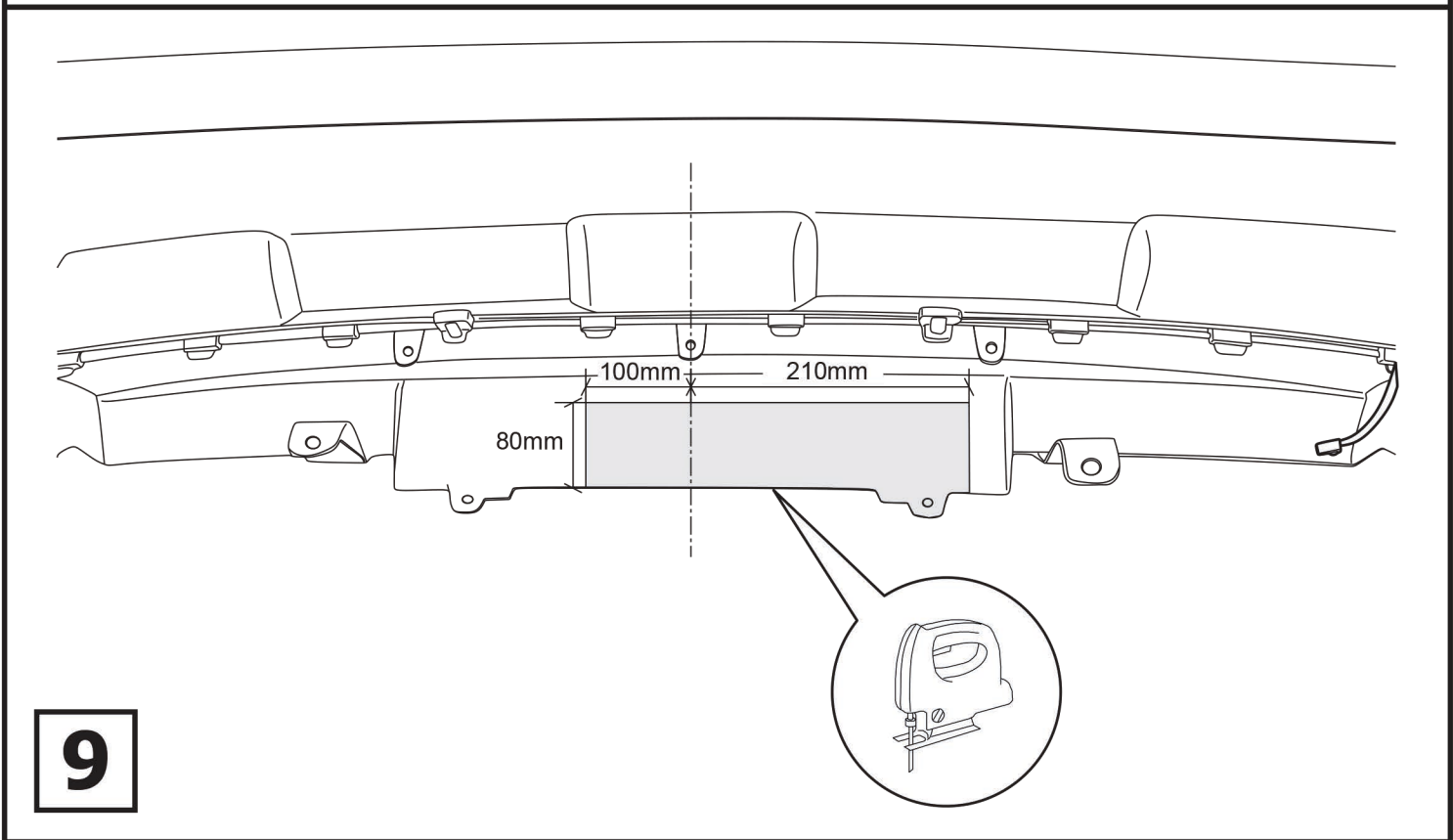

9

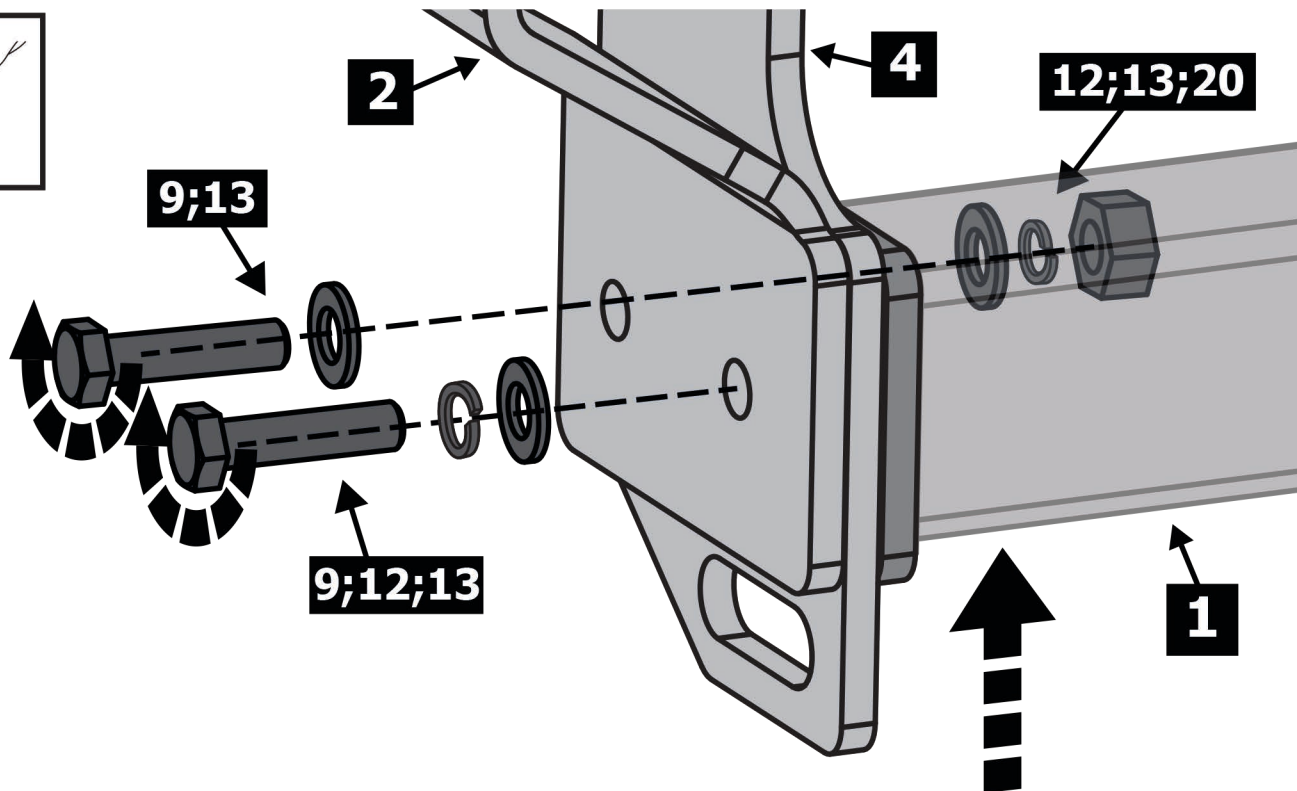
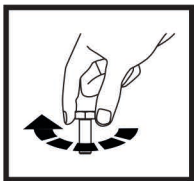

10

LEFT=RIGHT

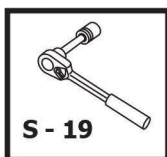
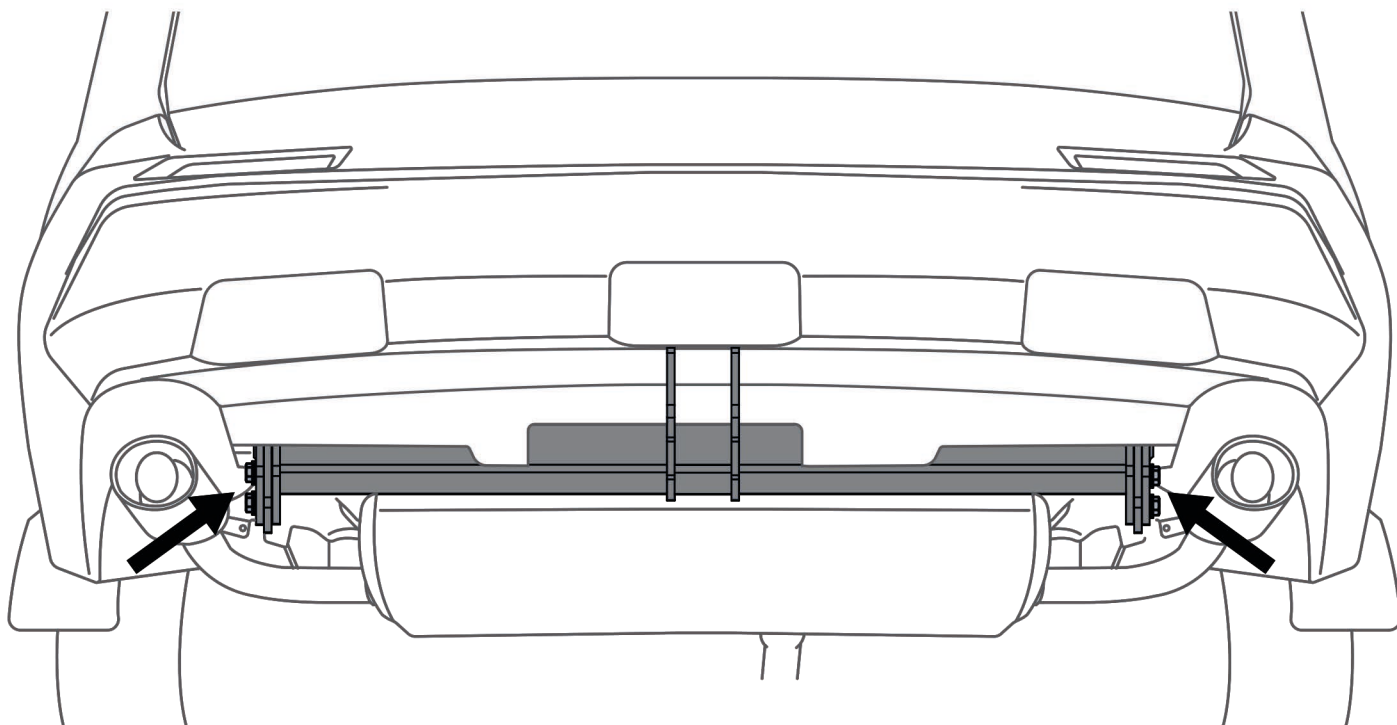

Затянуть резьбовые соединения балки с кронштейнами, затем кронштейнов с кузовом (M12=81 Nm)

11

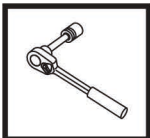
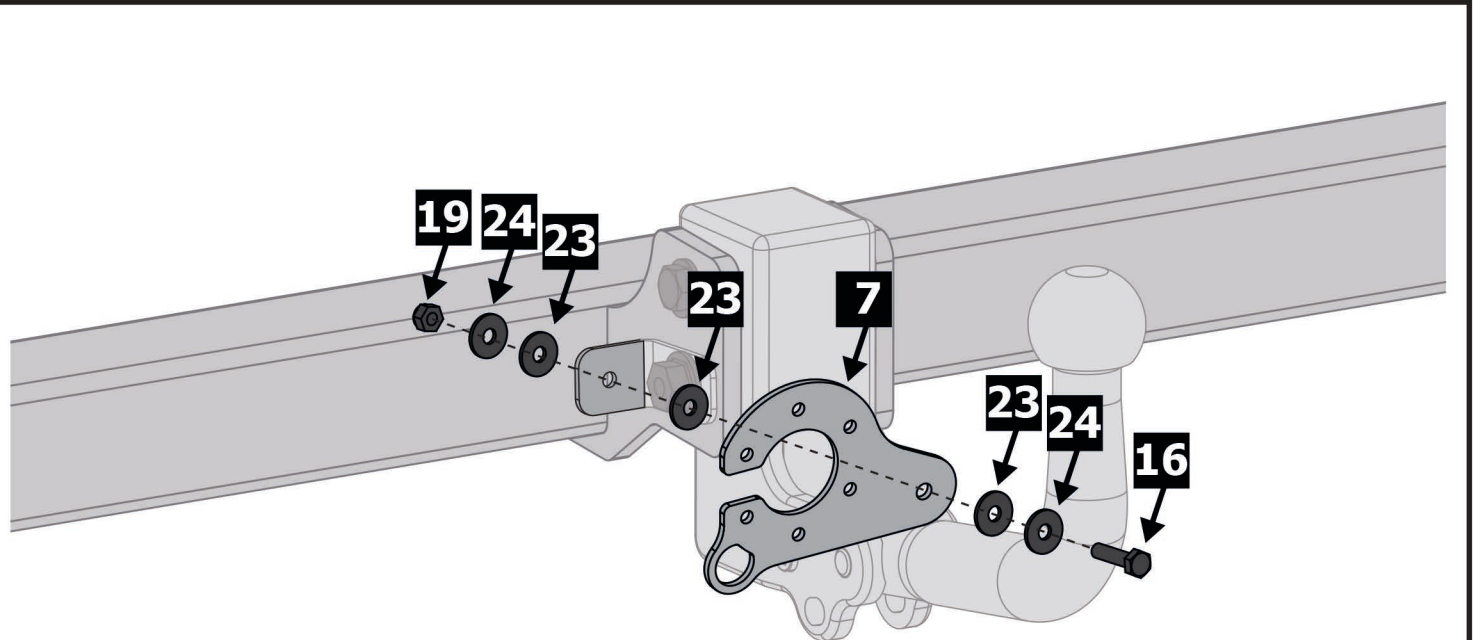
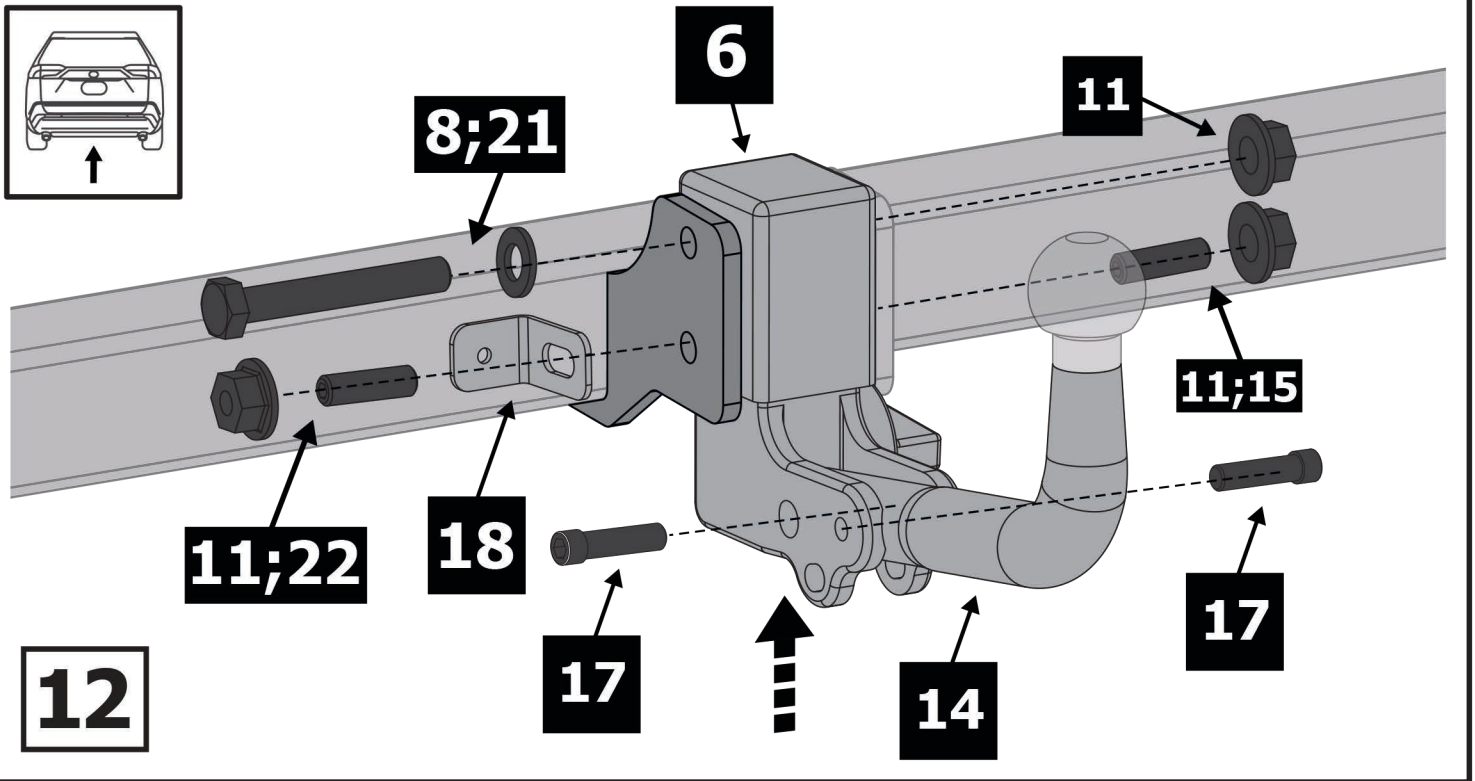
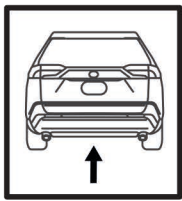

Затянуть все резьбовые соединения
M6 = 6 Nm M12 = 81 Nm

13